

into regions beyond

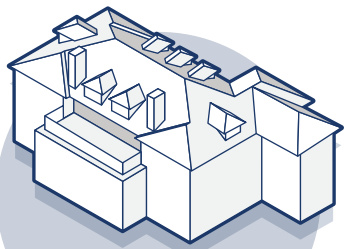

BERKELEY — CENTER — PILGRIMAGE



3D PAPER MODEL
PRINT, CUT, FOLD, ASSEMBLE



SHOW OFF YOUR COMPLETED ARTWORK ON SOCIAL MEDIA WITH THE HASHTAG **#BERKELEYCENTER**
FOLLOW US ON **@BERKELEYATYALE** TO SEE EVERYONE'S CRAFTY HANDIWORK!

Instructions



1. What you need:

- Scissors or cutter
- Craft glue
- Folding bone or thick needle
- Ruler

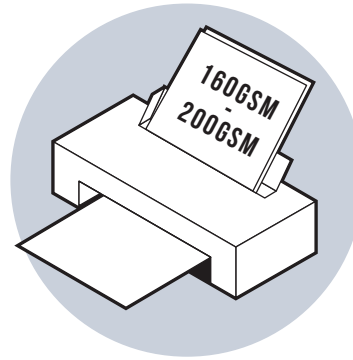

2. Print

Print the pattern on US-letter. We recommend to use 160gsm-200gsm paper weight.

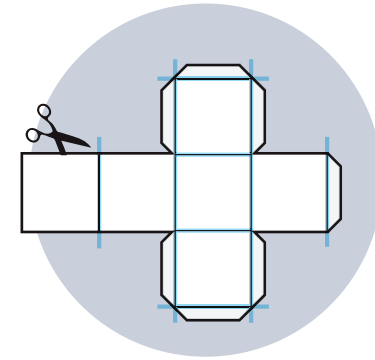

4. Score & Cut

Using a folding bone or a thick sewing needle and a ruler, score along the folding lines so you can easily fold the pieces. Cut the pattern pieces along the outer edge.

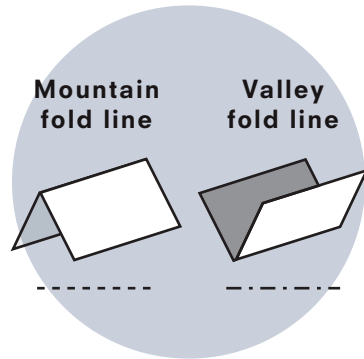

4. Fold

Fold along the creases either bringing the two edges away from you (Mountain Fold) or fold the two edges towards you (Valley Fold).

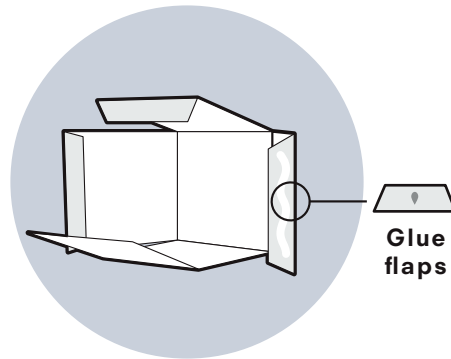

5. Glue

Glue each building block of the model separately. Apply the glue on the glue flaps as shown in the illustration.

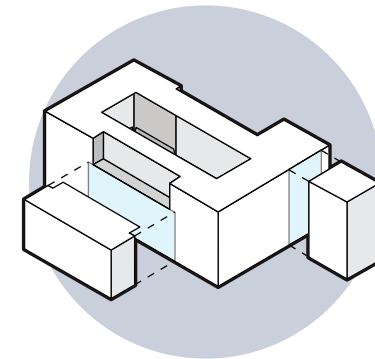

6. Assembly

Put all the individual pieces together. Refer to the small labels that indicate which piece goes where and assemble the model in the correct order.

Order of assembly

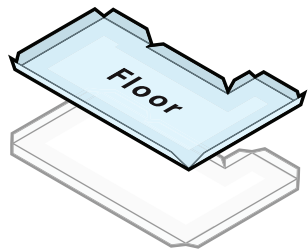

1.

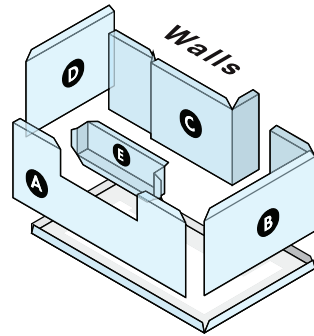

2.

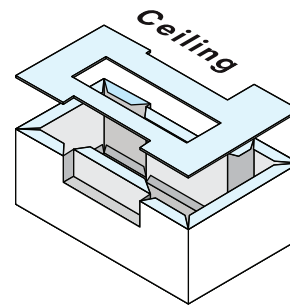

3.

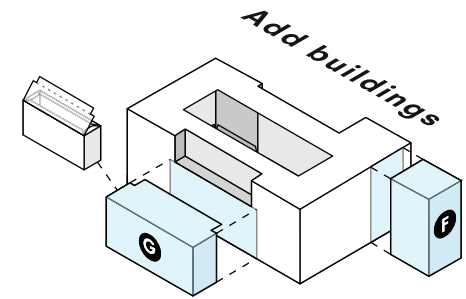

4.

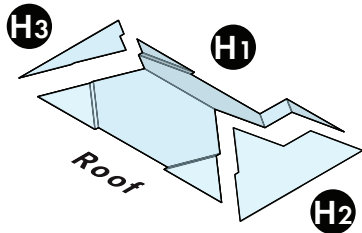

5.

FOLD ALL THE FLAPS TO THE INSIDE

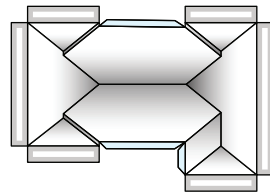

6.

NOW FIX THE CORNERS OF THE RECTANGULAR FLAPS WITH GLUE

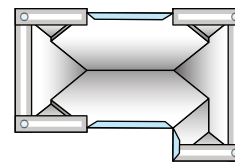

7.

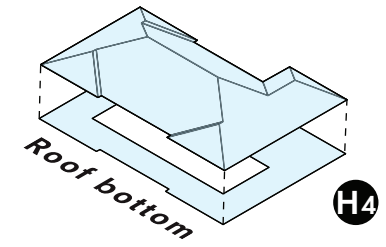

8.

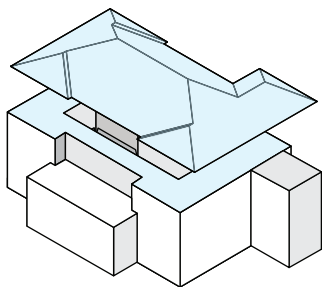

9.

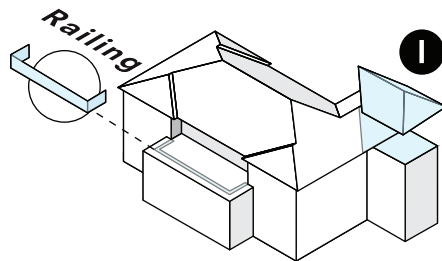

10.

GLUE THE WINDOW BOXES FIRST AND ADD THE LITTLE ROOF PIECES ON TOP LAST

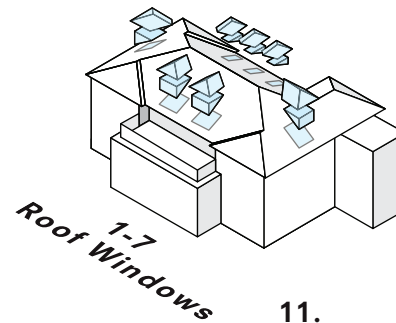

11.

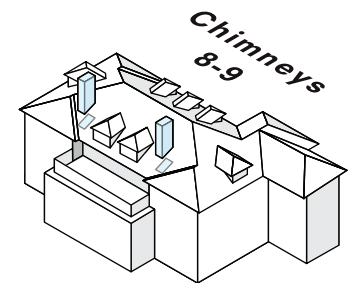

12.

Order of assembly

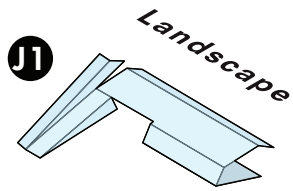

13.

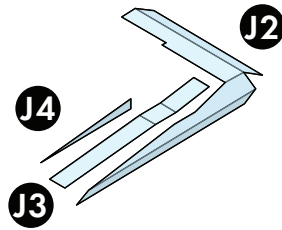

14.

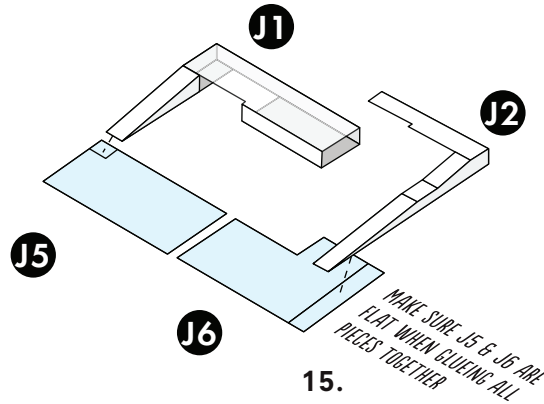

15.

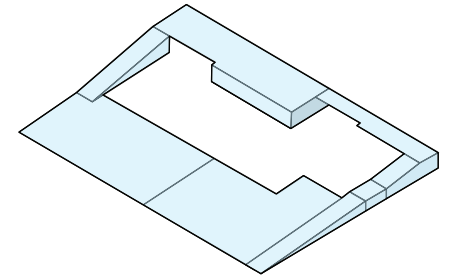

16.

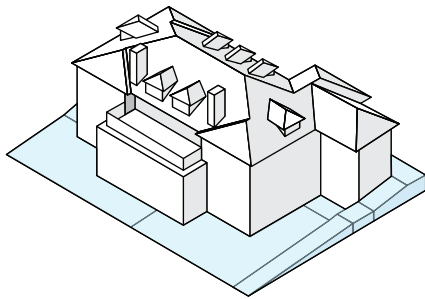

17.

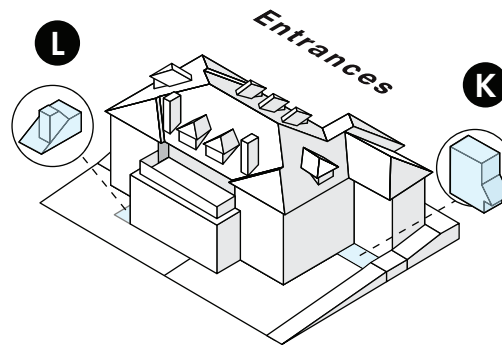

18.

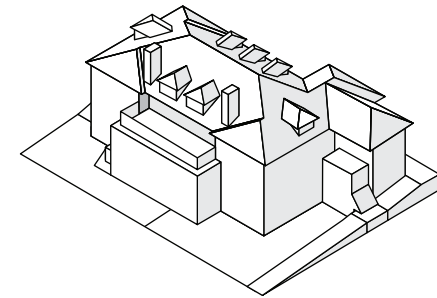

19.

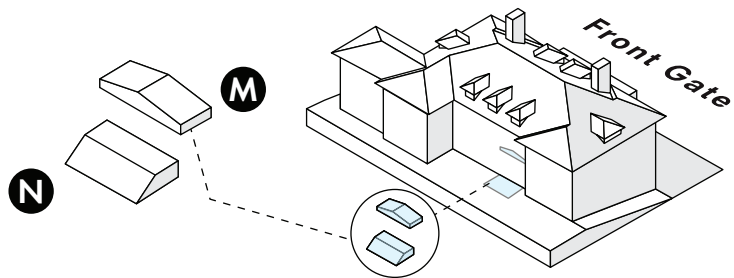

20.

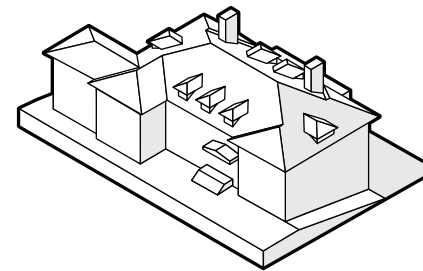

Done

FLOOR

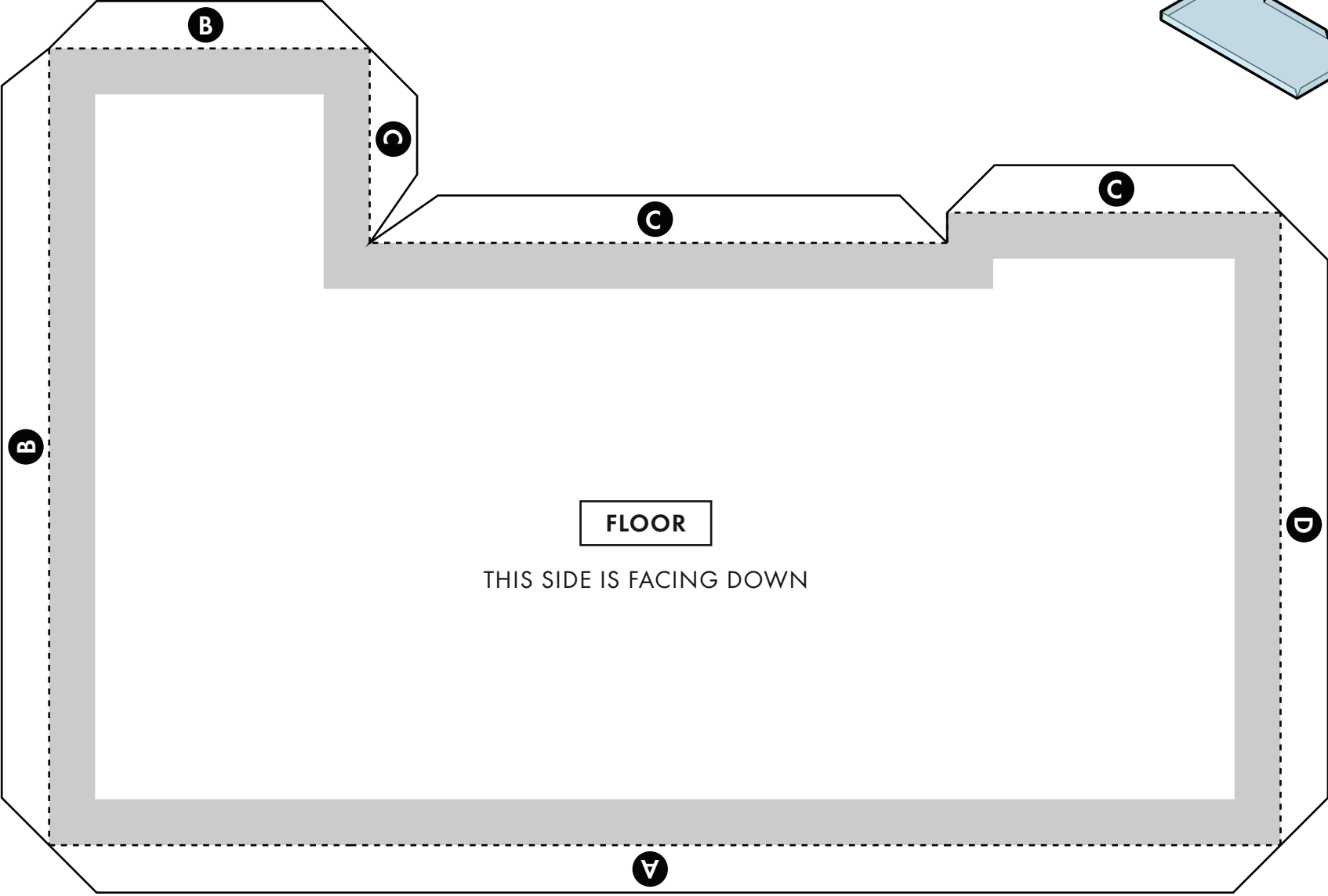
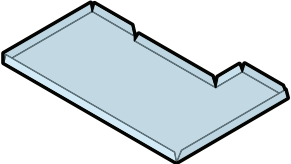

FLOOR

THIS SIDE IS FACING DOWN

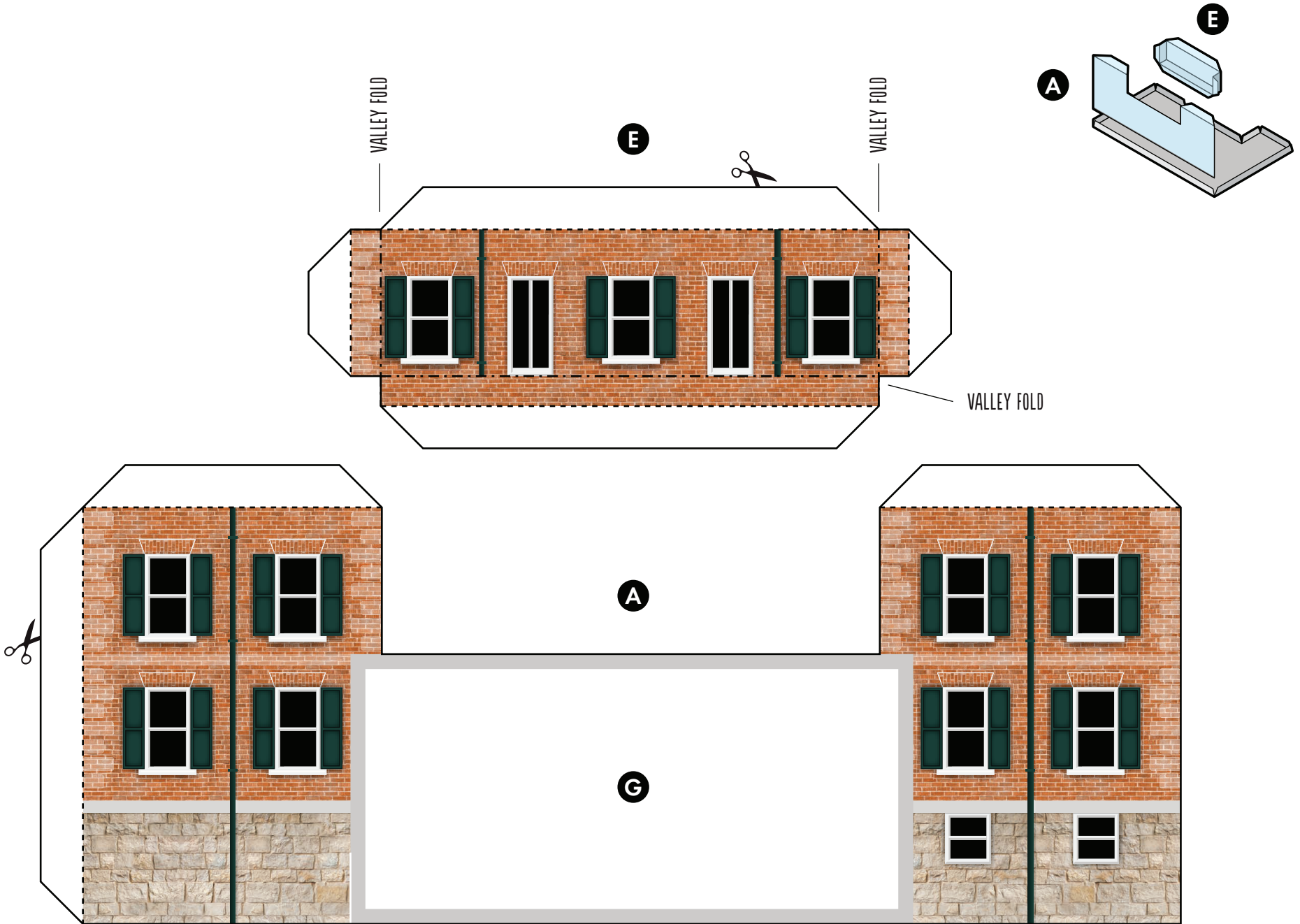

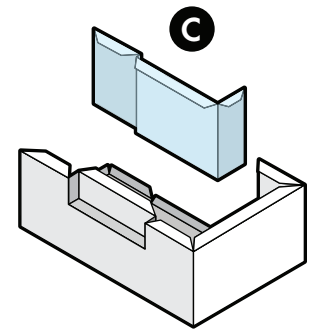
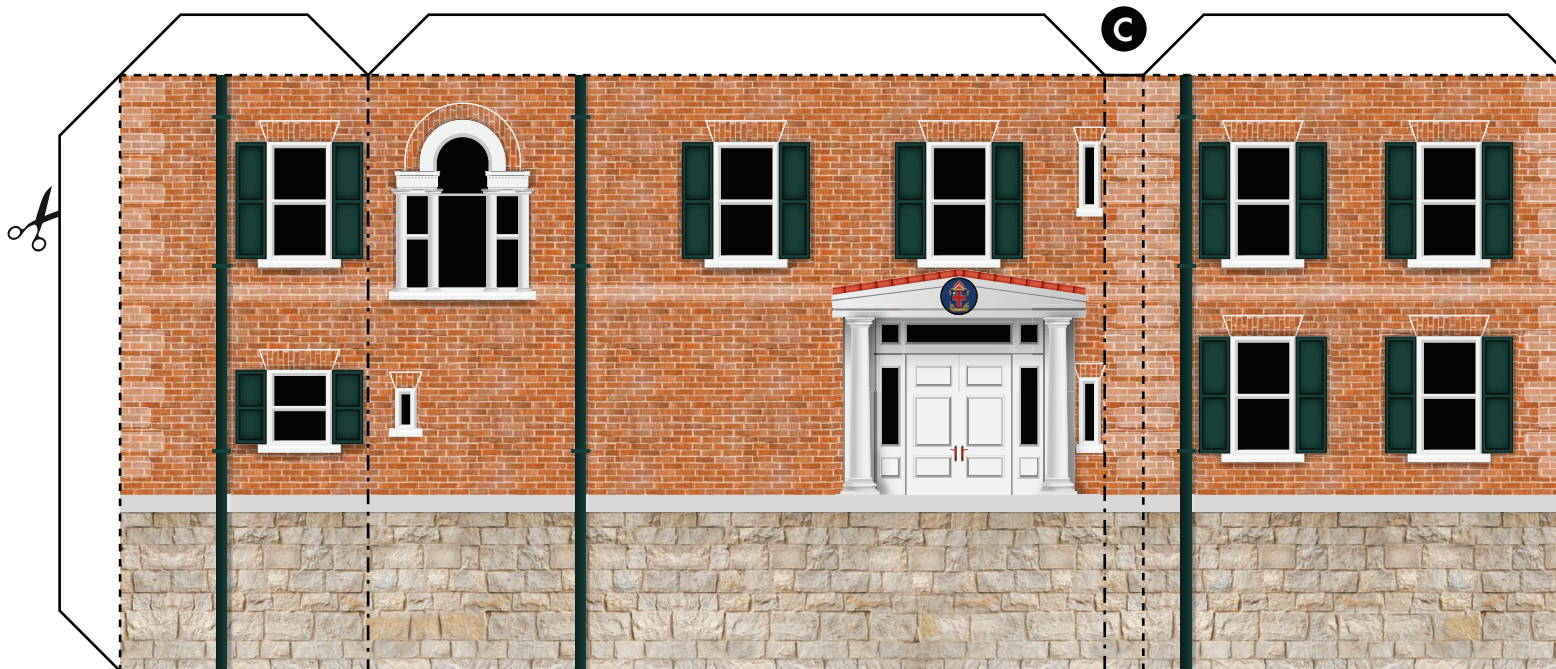
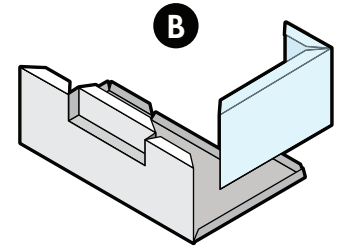
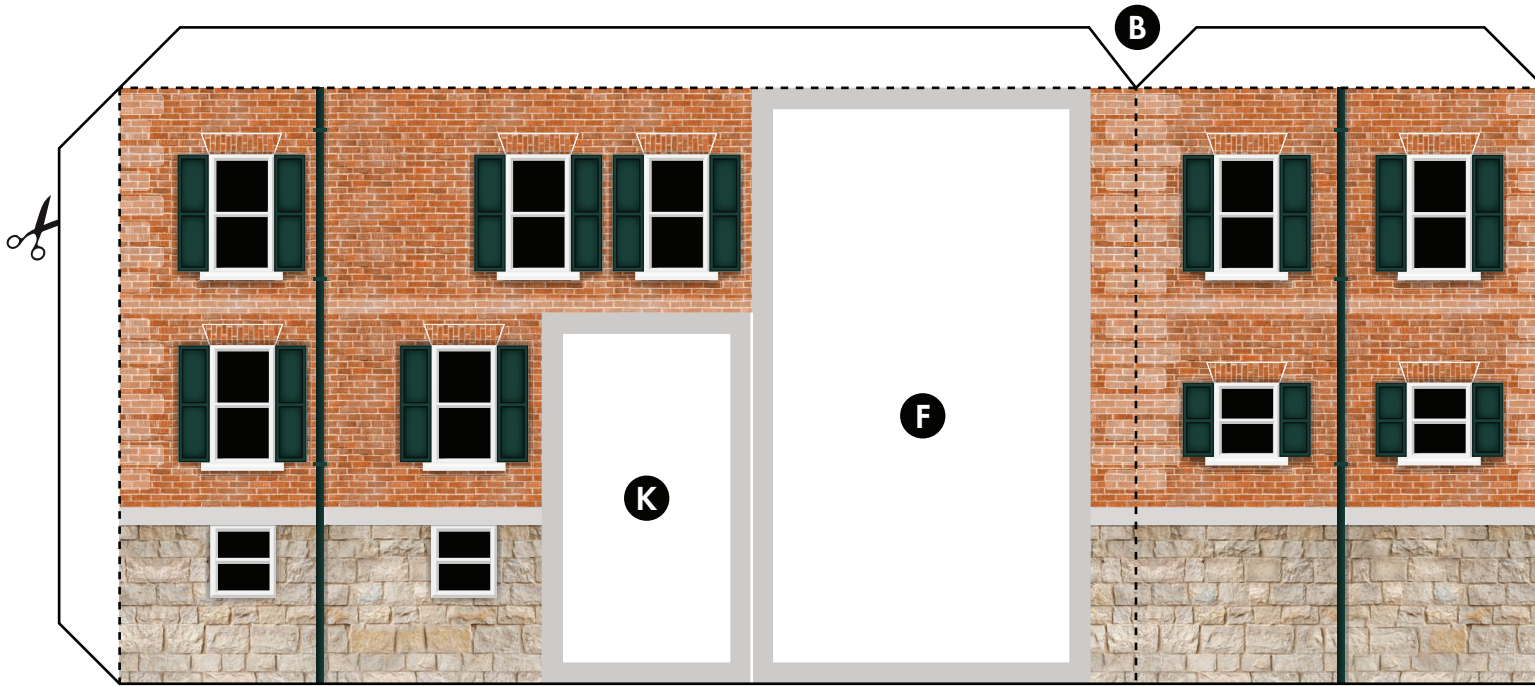

VALLEY FOLD

VALLEY FOLD

CHIMNEYS

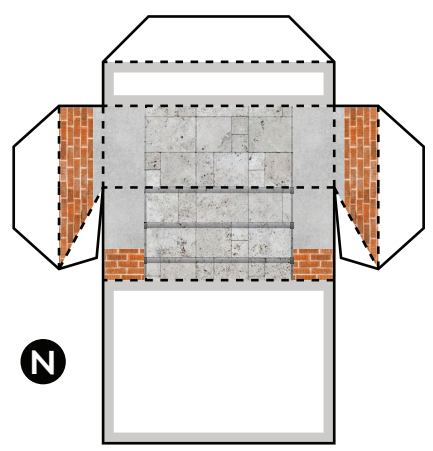
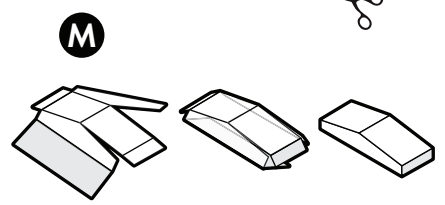
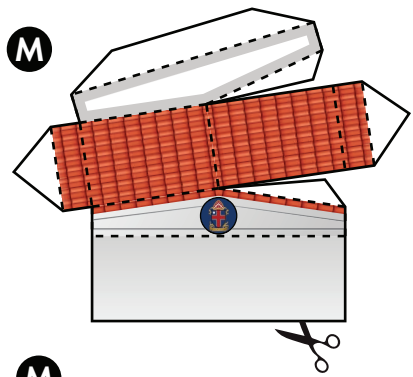
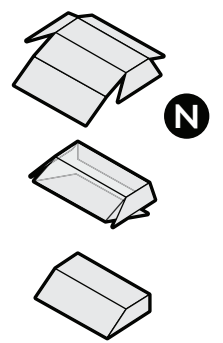
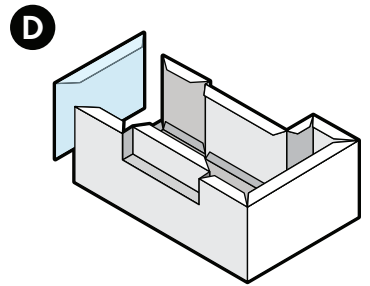
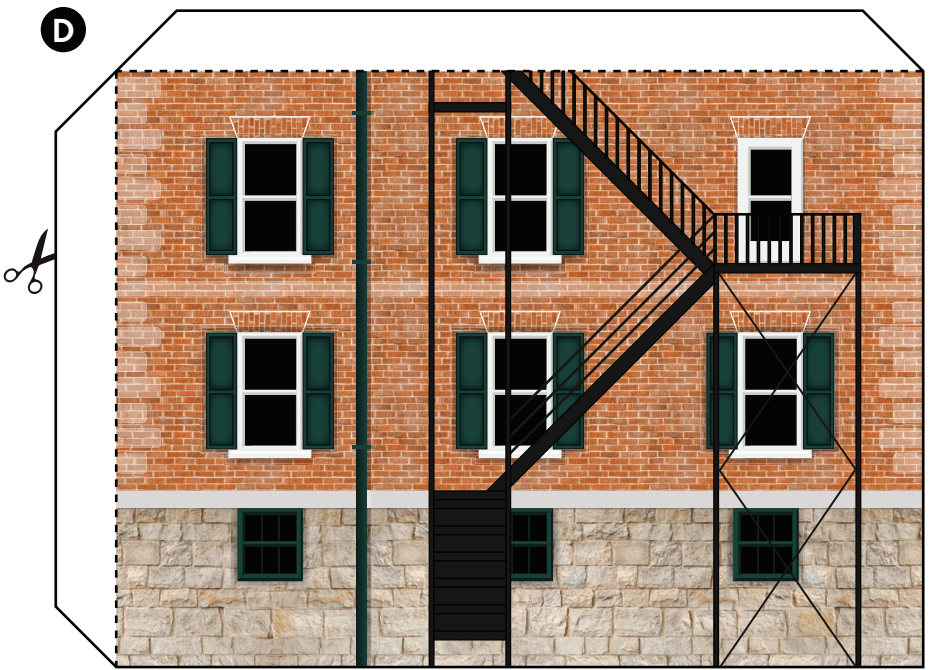
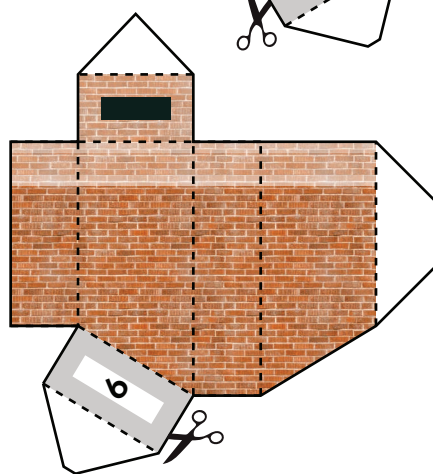
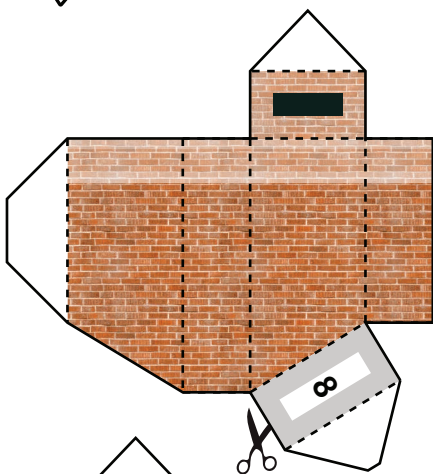
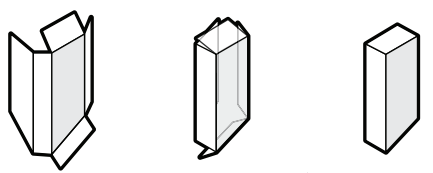

CEILING

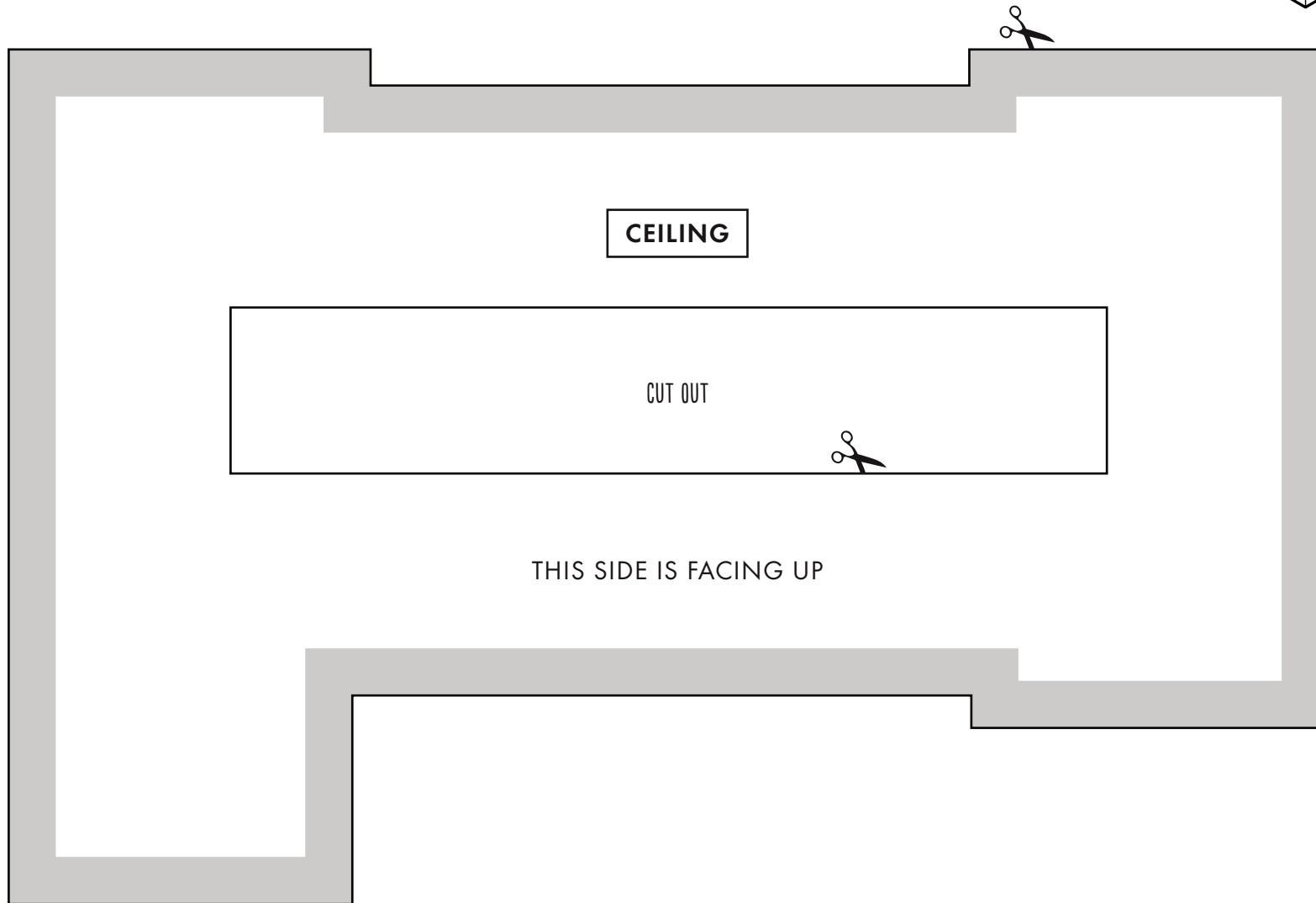
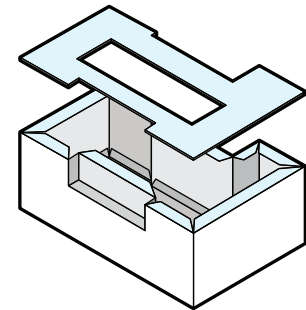

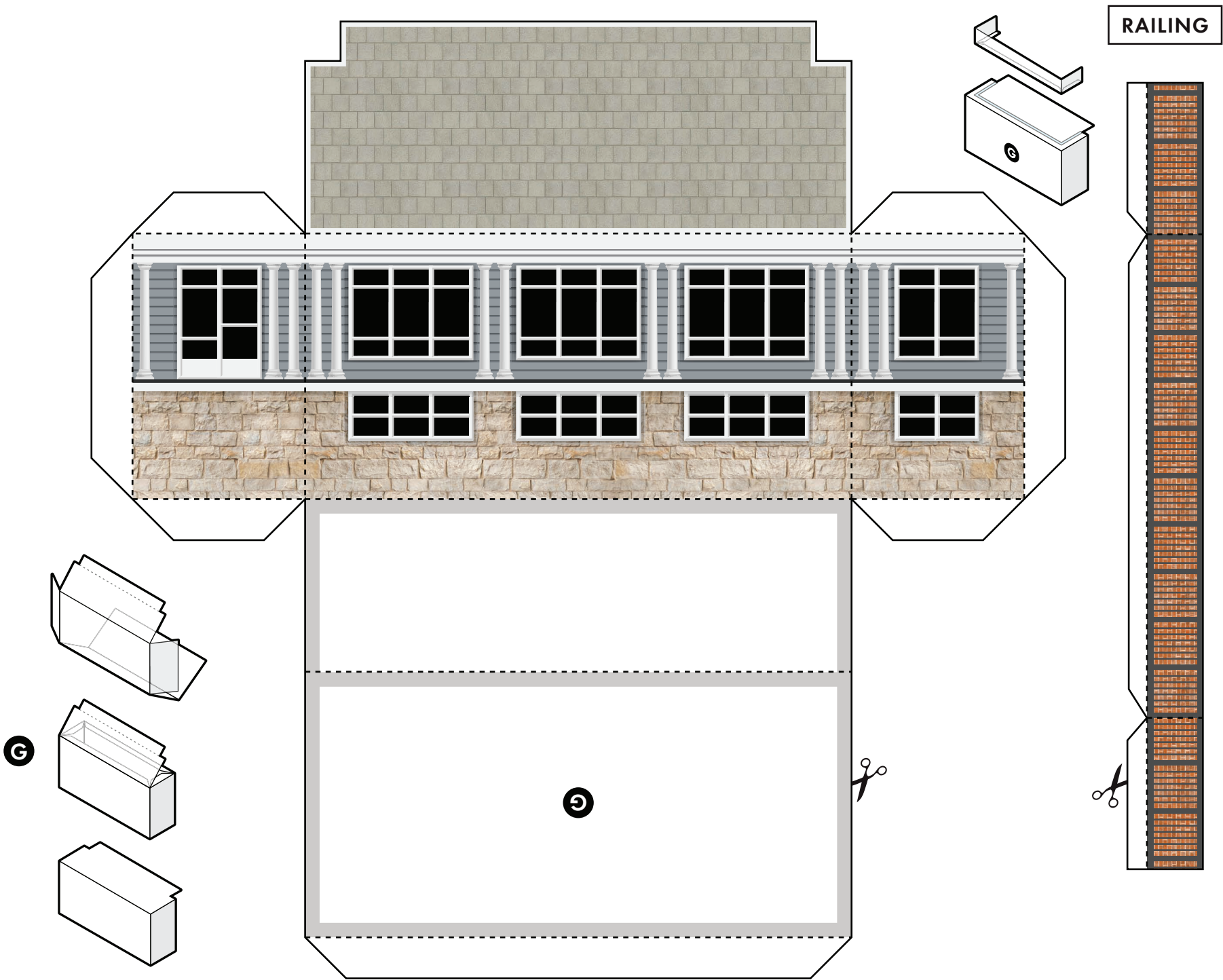

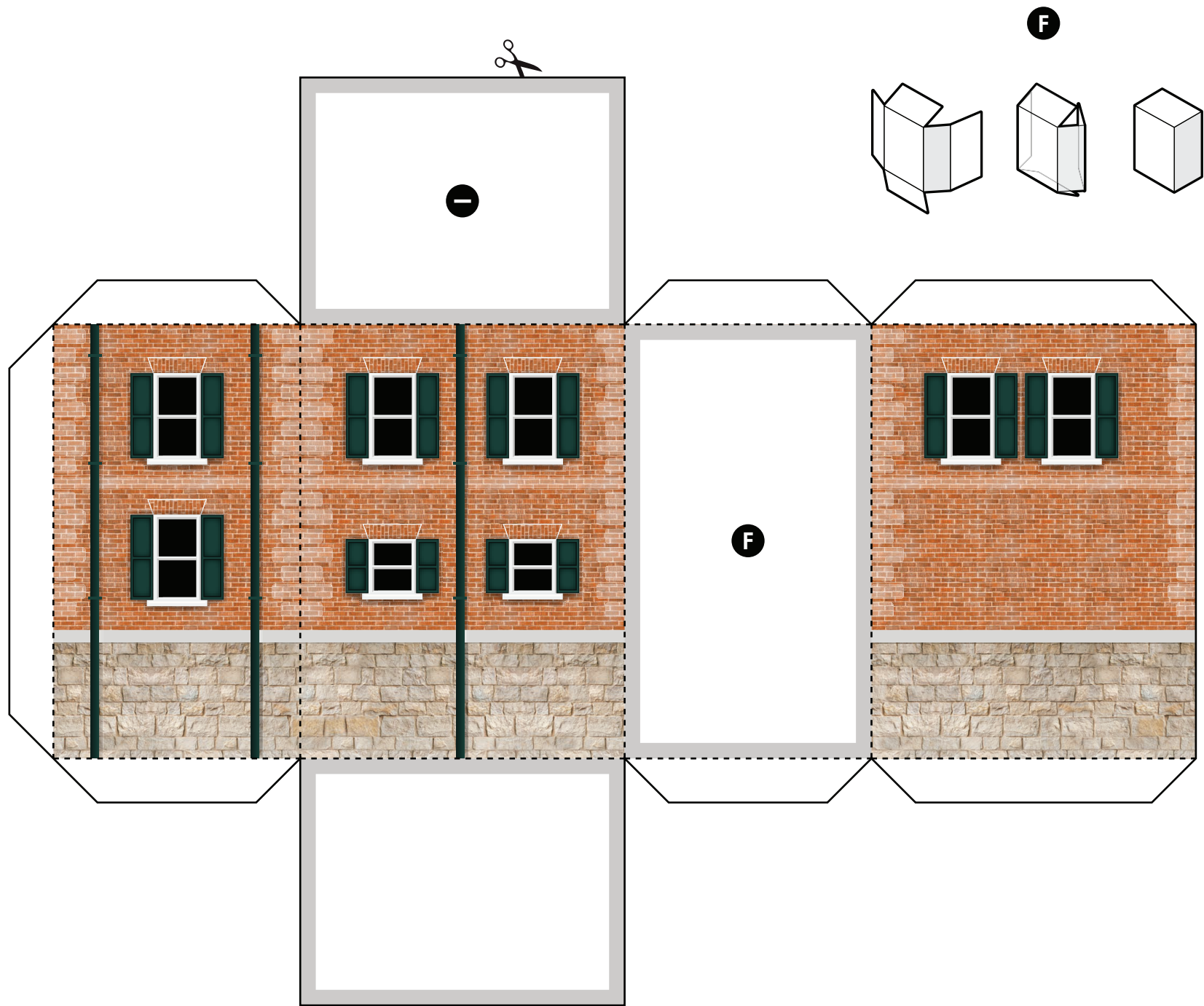

ROOF

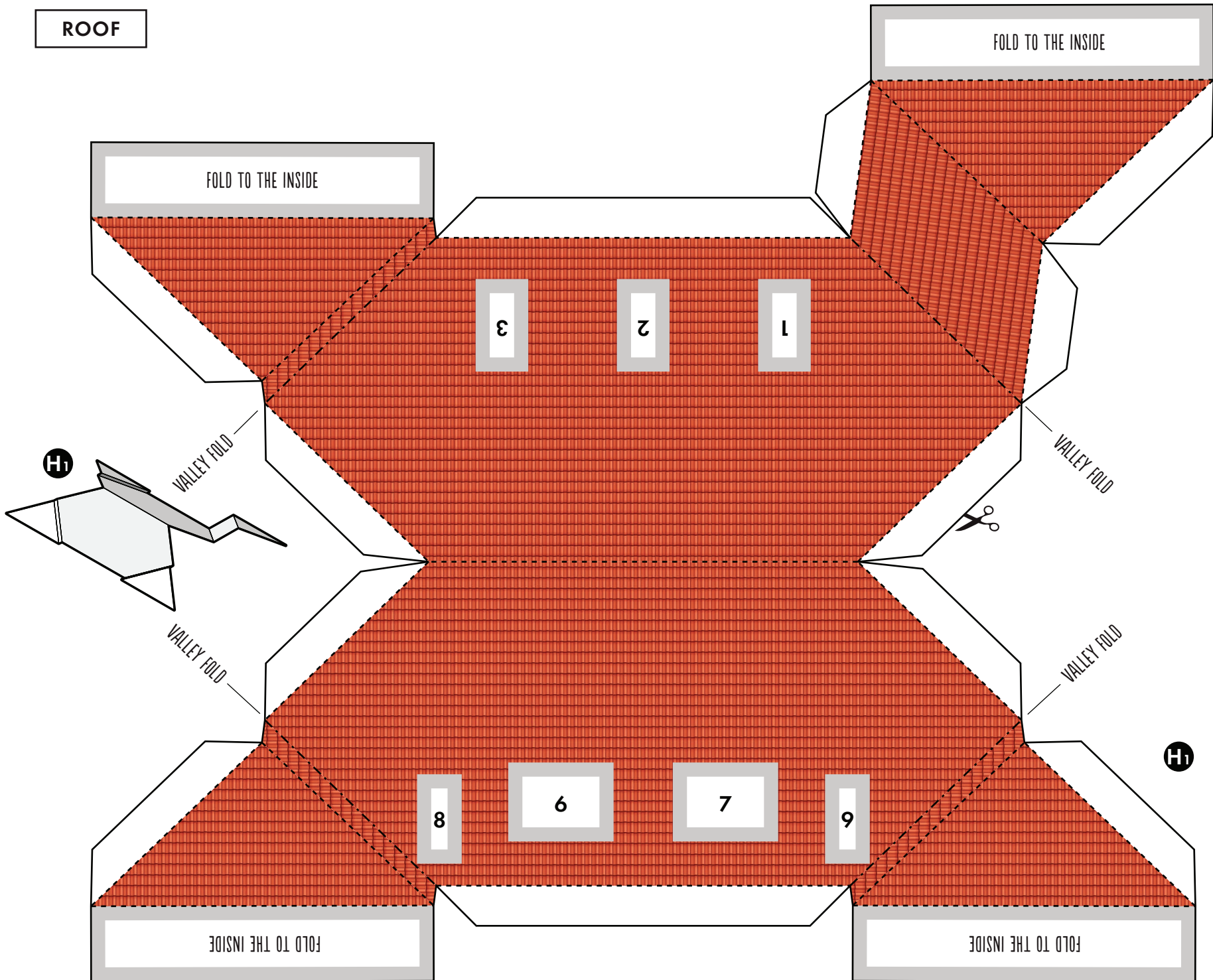

ROOF

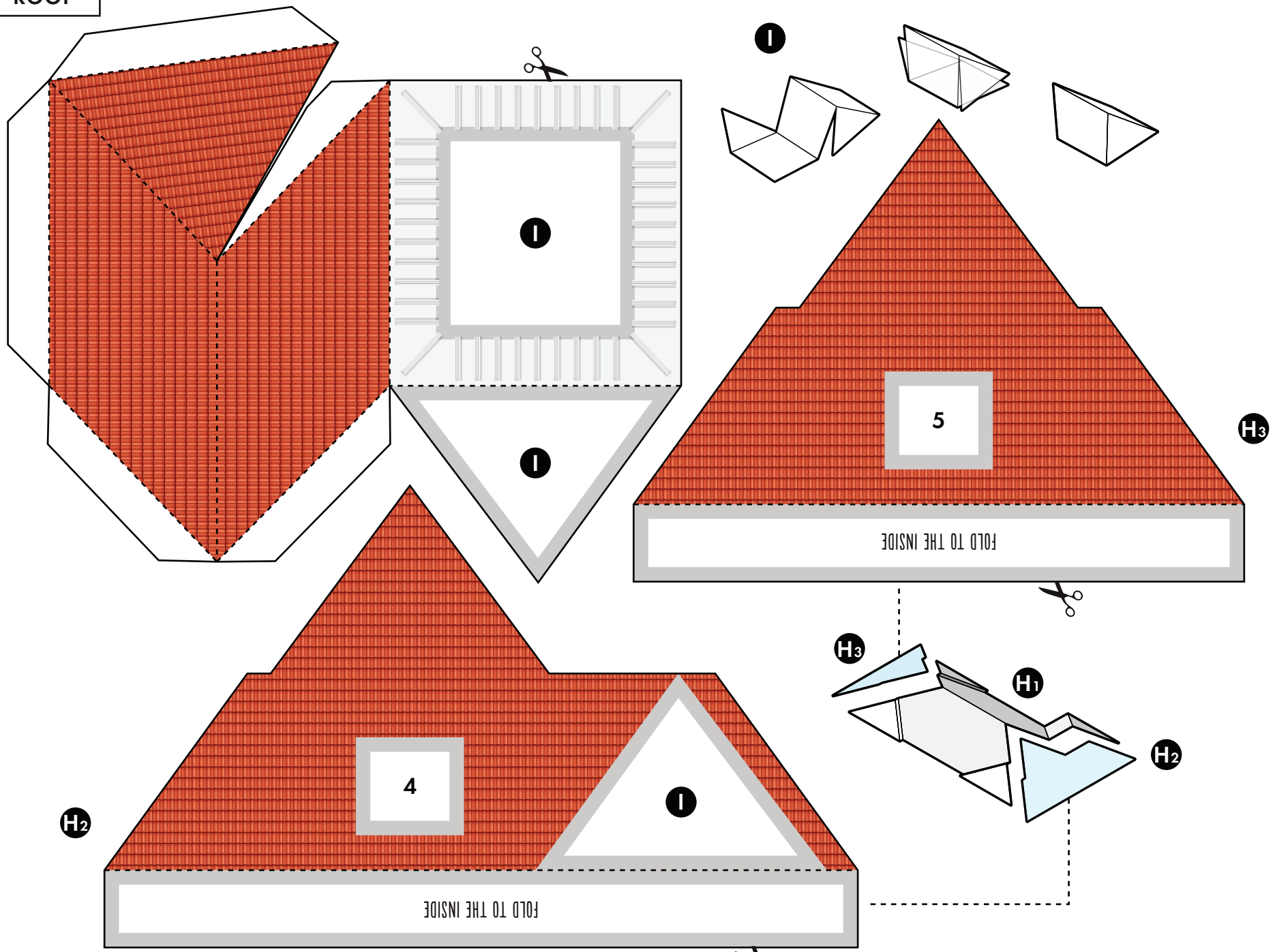

ROOF

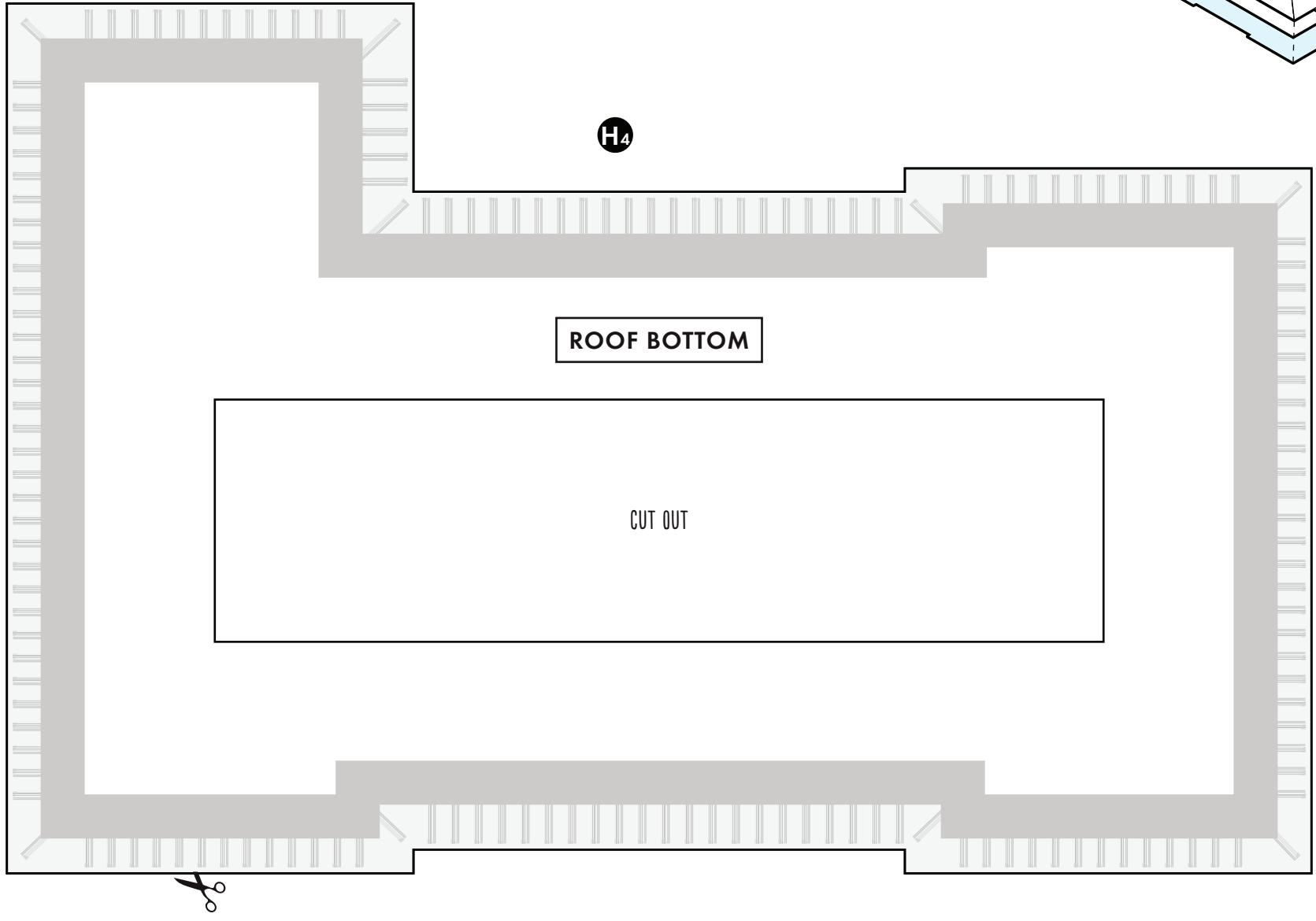
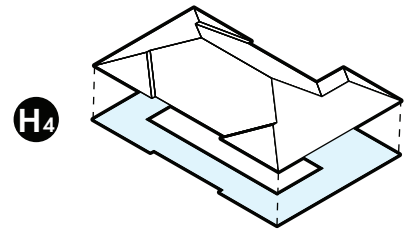

ROOF WINDOWS

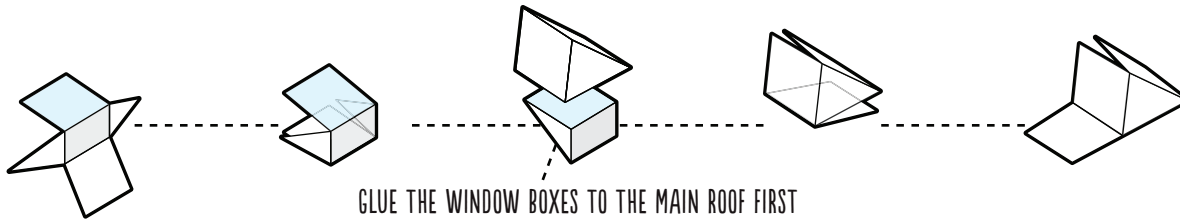

GLUE THE WINDOW BOXES TO THE MAIN ROOF FIRST
ADD THE SMALL ROOFS ON TOP

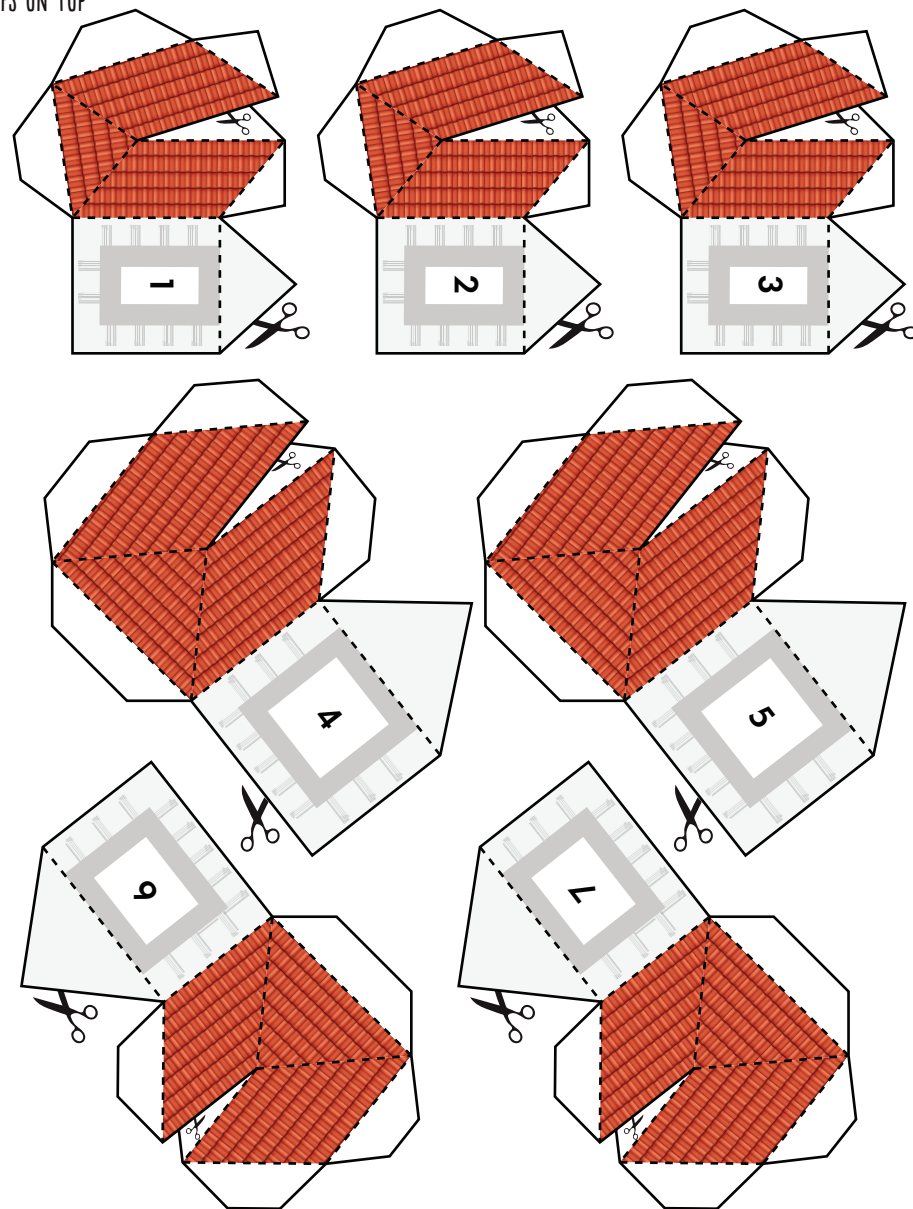
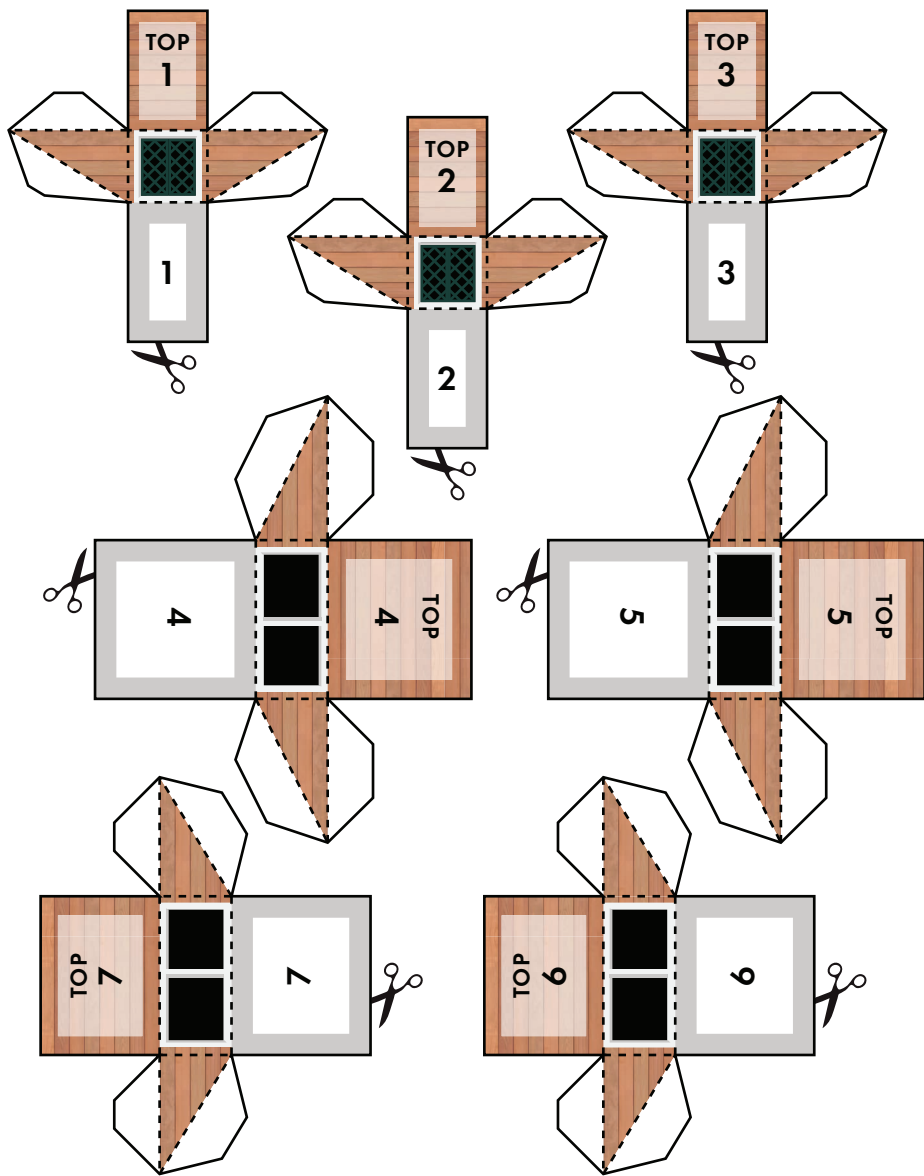

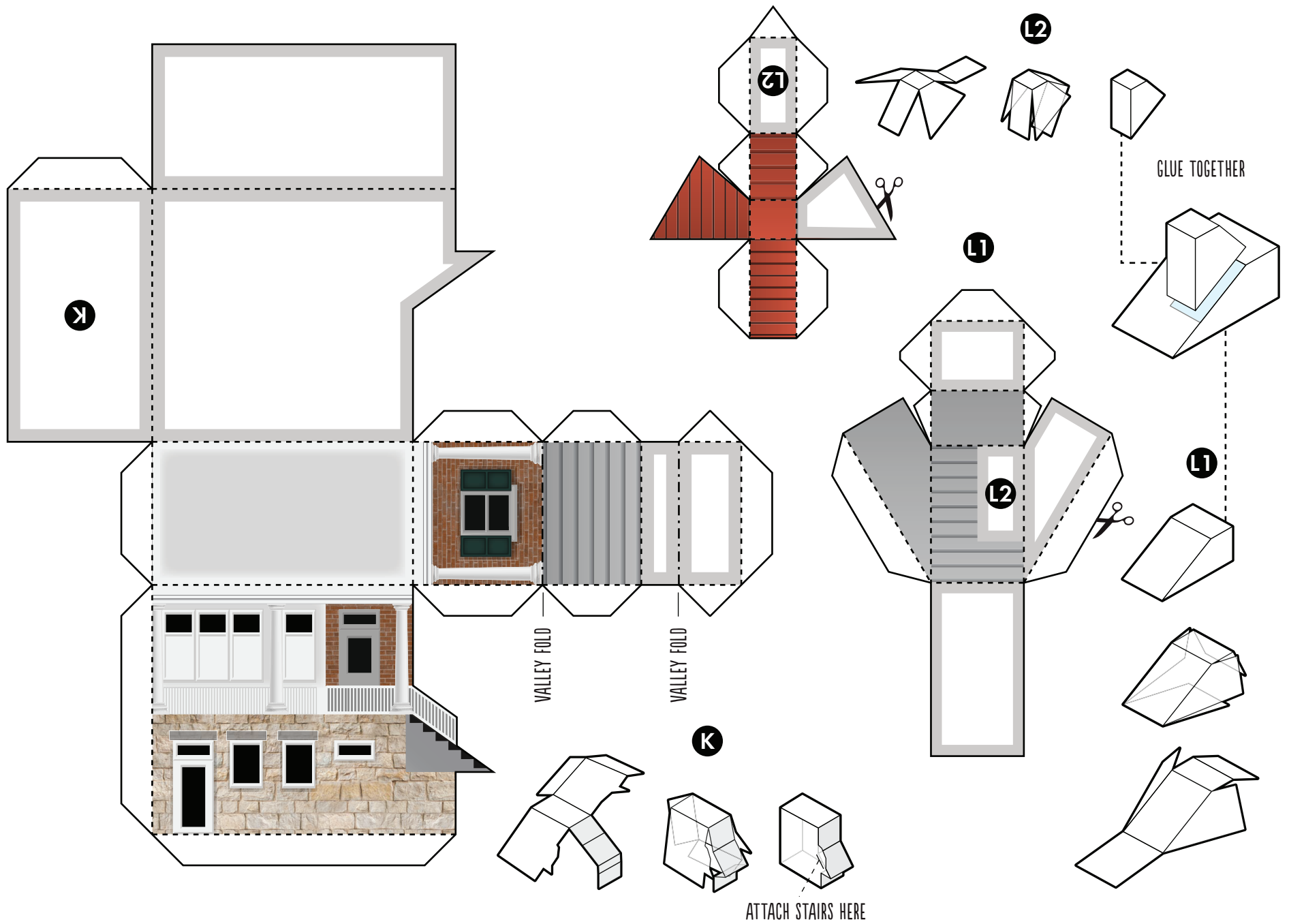

LANDSCAPE

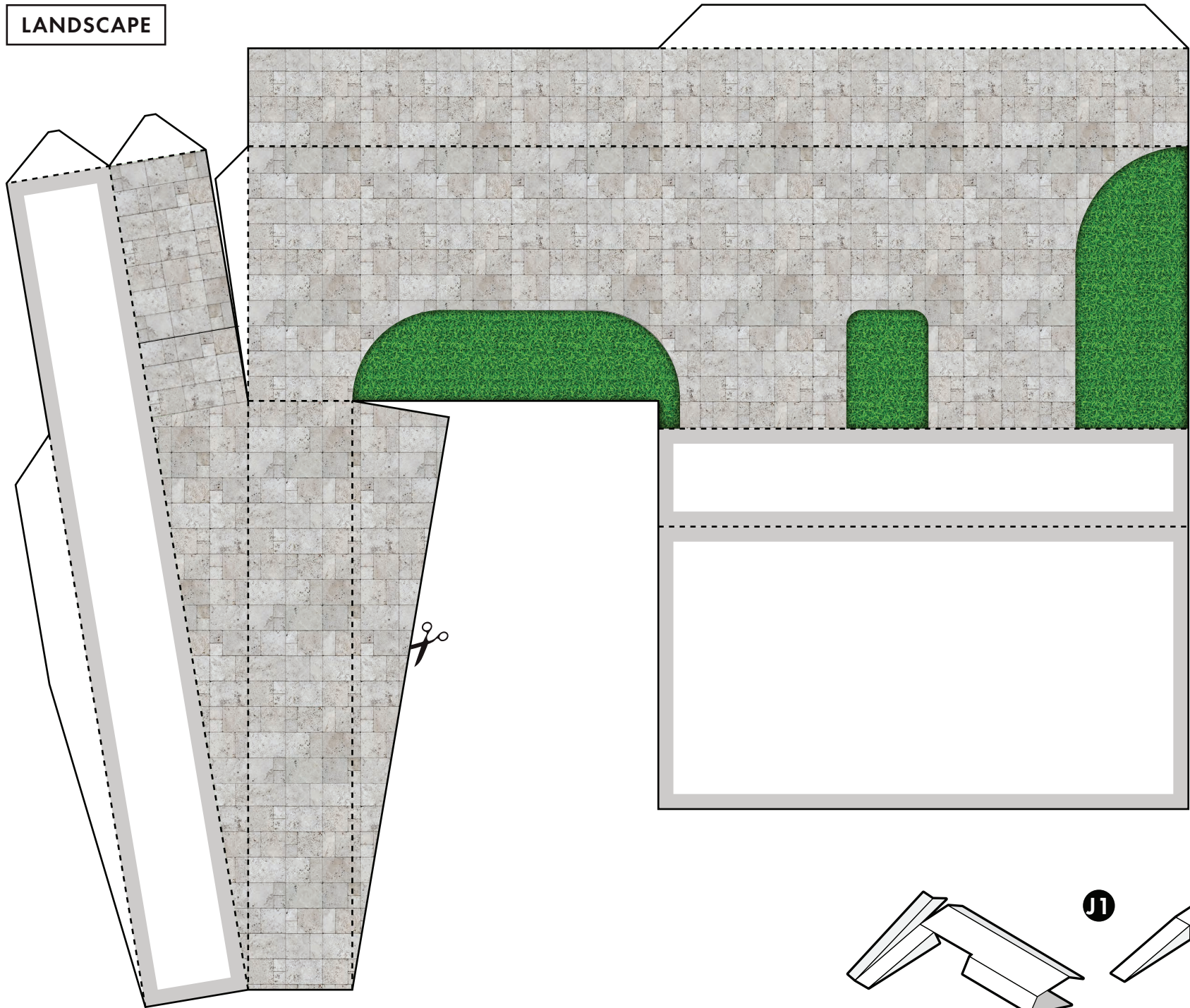

11

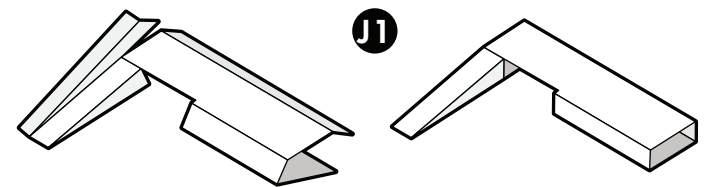

LANDSCAPE

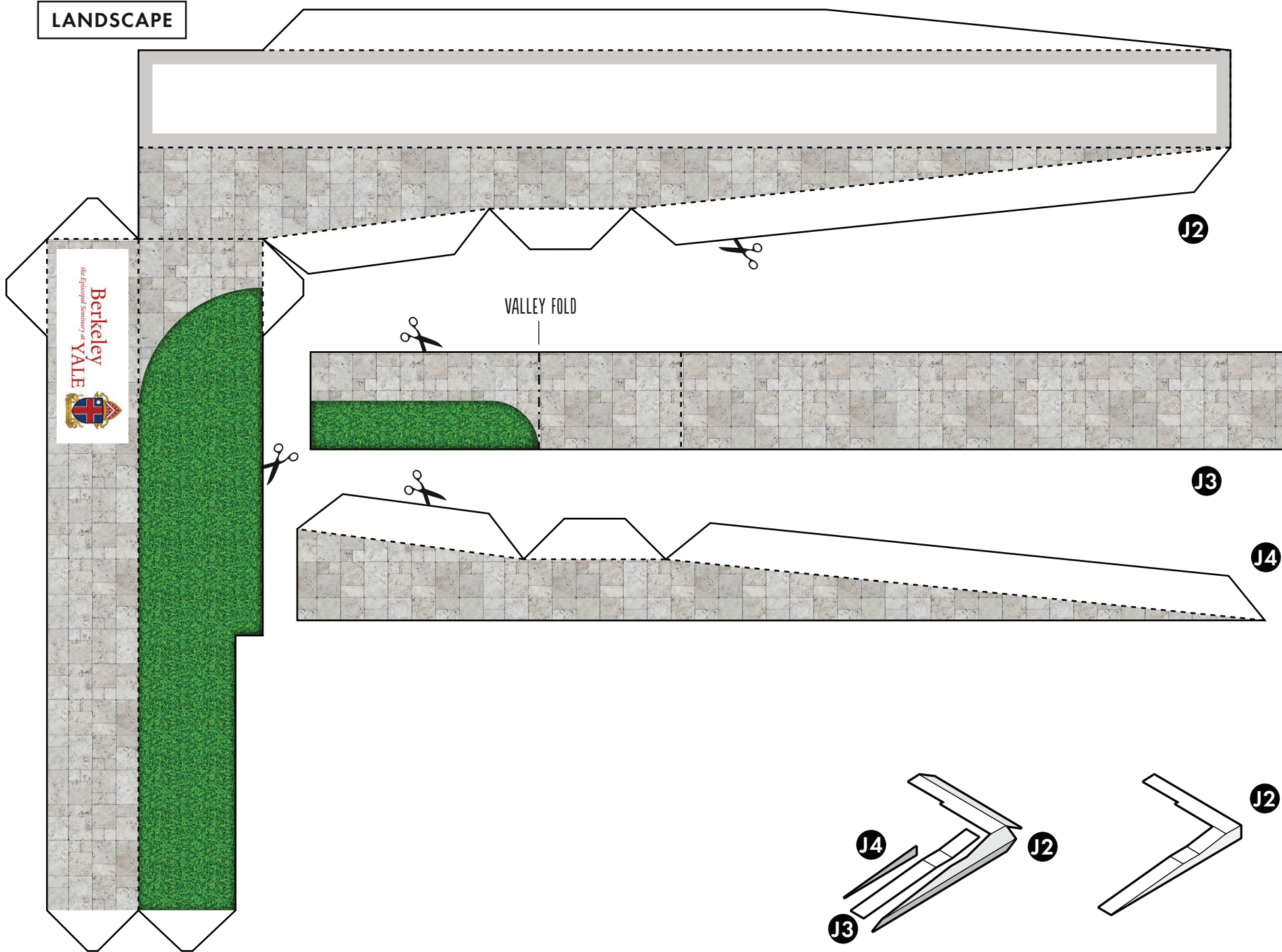

LANDSCAPE



J5

